

29240

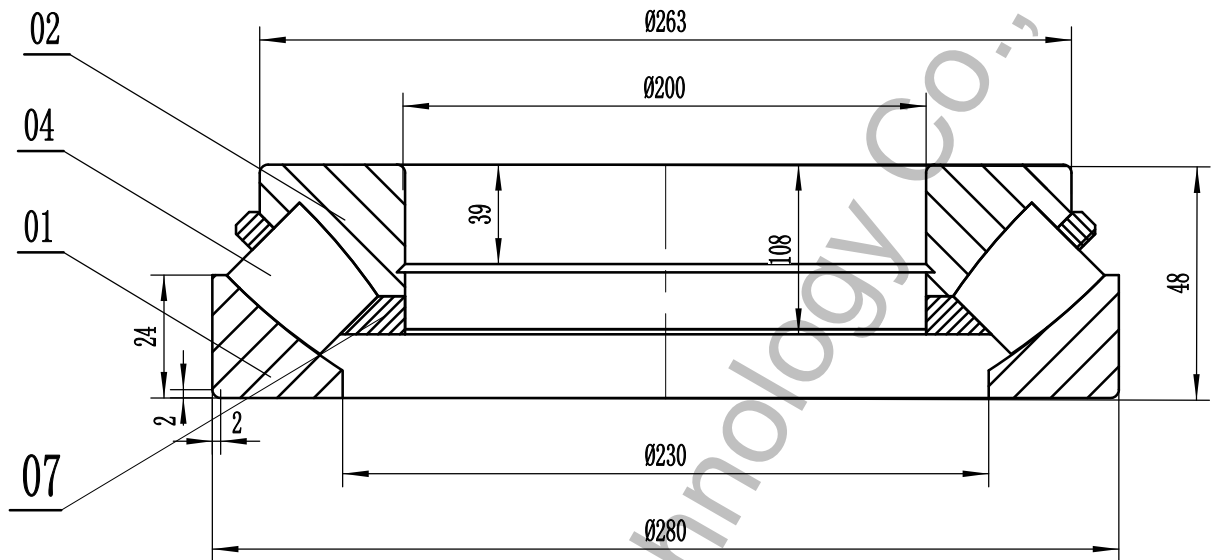

1 rated load: $C_r = 560 \text{ KN}$; $C_{or} = 2590 \text{ KN}$;

2 Heat treatment according to the current standards.

Remark:



1. Luoyang JCB Bearing Technology Co., Ltd is a technical Inc, specialize in designing and manufacturing thrust bearing, we can design and manufacture all kinds of thrust bearing according to client's requirement.
2. This drawing is reference for user, if you need formal drawing, please contact with us sales@jcb-bearing.com, the official drawing will be submitted after order confirmation.

07	Cage	2	Brass CuZn39Pb2-EN 1652:1997			
04	Roller		Steel 100CrMnSi6-4-ISO 683-17:1999			
02	Inner ring	1	Steel 100CrMnSi6-4-ISO 683-17:1999			
01	Outer ring	1	Steel 100CrMnSi6-4-ISO 683-17:1999			
No.	Designation	Qty	Material	unit	total	Remark
				Weight (kg)		
			29240			
Add: No. 3 Lianmeng road, Luoyang, Henan, China. Postal: 471003 Phone: +86-379-68611678 Fax: +86-379-68611679 E-mail: sales@jcb-bearing.com Website: www.jcb-bearing.com www.sphericalrollerthrustbearing.com			Thrust spherical roller bearing		Weight (kg) Scale	
		S			8.6	—
			Total page 5		Page No. 1	
Luoyang JCB Bearing Technology Co., Ltd						